

Operation and Maintenance Manual

Moduflex High Performance Operable Walls

This manual provides important safety, operation and maintenance information for your ANC Moduflex operable wall(s). These systems have been custom manufactured to give you years of un-interrupted service.

Should you wish scheduled or periodic service, please consult your local ANC authorized installing distributor. If you ever need factory assistance, please refer to the following information when contacting ANC:

ANC Order No: _____









Project Name: _____

Project City: _____ Project State: _____

Moduflex Model(s):	1. _____	STC: _____
	2. _____	STC: _____
	3. _____	STC: _____







Thank you for selecting ANC products.

Rules For Safe Operation - Manually Operated Walls

-  1. Do not attempt to operate ANC operable walls until you have read thoroughly and understand completely all instructions, safety rules, etc., contained in this manual. Failure to comply can result in accidents involving serious personal injury. Save this manual and review it frequently for continuing safe operation and for instructing others who may operate the operable walls.
-  2. While moving a panel, or panel pair, always maintain continuous control of it by holding onto its back edge (the edge away from the direction of travel) and by moving it at a walking pace. Letting go of moving panel(s) or pushing them at a speed that you cannot control may result in injury to others or yourself or in damage to the panel or other property.
-  3. While moving a panel, or panel pair, always look ahead to where you are going to be sure that the path ahead is clear. Some ANC operable wall panels weigh as much as a ton, and you should use the same caution as you would when safely driving a car.
-  4. As you unfold a panel pair, if any, make sure to not pinch your fingers between the hinged panel edges. As you fold a panel pair, make sure to not pinch your fingers between the panel faces.
-  5. Never slam a panel, or panel pair, into another panel or into an adjoining wall. Doing so may risk personal injury or damage to the panel.
-  6. Never slam a panel into a track intersection or curve, if any, or a track stack area, as this may cause damage to the track, trolleys, trolley suspension bolts or panel header.
-  7. Before returning each panel to its storage area (storage closet), inspect the interior of the area (pocket) to be sure that nothing has been stored in the vacant area (pocket) and that there is no one in the area (pocket) that could be hit or trapped by the panel.
-  8. Before closing and/or locking pocket doors, if any, be sure that there is no one in the pocket.
-  9. Each ANC operable wall panel is suspended from one or two trolleys each of which is attached to the panel by a threaded suspension bolt that is fitted with a locking plate. **LOCKING PLATES MUST NEVER BE REMOVED**, except by an authorized ANC service technician, and, then, only momentarily while adjusting the elevation or plumb of a panel. Moving a panel with a locking plate removed may result in the suspension bolt unthreading from the panel, causing the panel to fall.

“Sound” Set Up Practices - Manually Operated Walls

ANC operable walls are engineered to provide a high degree of sound isolation between adjacent function rooms. Since even small leaks will undermine the acoustical performance of the partitions, it is important to use “sound practices” every time that each wall is “set up.” Below is a summary of key practices.

-  1. Check to be sure that the adjacent panels are vertically aligned with each other along their entire vertical edges. Generally, no more than a 1/2” gap should be present between the hard edges of adjacent panels. The flexible vertical seals should be touching one another tightly from top to bottom.
 -  2. While setting up panels having tool-actuated Manuseals™, if any, push on the back edge of the panel to assure that its lead edge is firmly engaged with the trail edge of the preceding panel, jamb, or intersecting wall, then extend the top and/or bottom seals to set the panel in position. Be sure to extend the Manuseals on every panel. The top seal should engage the track soffit and the bottom seal should engage the floor surface.
 -  3. While setting up a pass door panel, if any, having tool-actuated bottom Manuseals, be sure to extend the seals on both legs as well as on the door.
 -  4. While setting up an expandable panel, if any, be sure that the telescoping nose is extended to fully engage the adjoining or intersecting panel or wall for a tight seal top to bottom.
 -  5. While setting up a wall to seal through the slot in a pocket door, if any, be sure to close both pocket doors and both slot closers tightly against the panel faces.
-  **NOTE:** A good way to check for sound leaks is to check for light leaks. After an operable wall has been set up completely, turn on the lights in a room on one side of the operable wall, turn off the lights in the room on the other side of the operable wall and, standing in the darkened room, look for light leaks. If you see light leaks, then reset the affected panels for a tighter fit. If the light leaks persist, contact your ANC authorized distributor for servicing.
-  **NOTE:** At the time that the operable walls were installed, the trolley suspension bolts on each panel were adjusted so that the panel was hanging vertically plumb. Over time, due to live loading and differential settling of the building, the operable wall tracks may move causing panels to hang slightly out of plumb and may possibly require readjustment of the panels. In this case, contact your ANC authorized distributor. Never attempt to adjust the trolley suspension bolts yourself. Refer to caution 9 in the section, “Rules For Safe Operation.”

Panel Identification No. (PIN)

Each ANC operable wall panel has its own, unique, panel identification no. (PIN) that is printed on a label, as shown in the figure below, which is adhered to the trail edge of the panel.

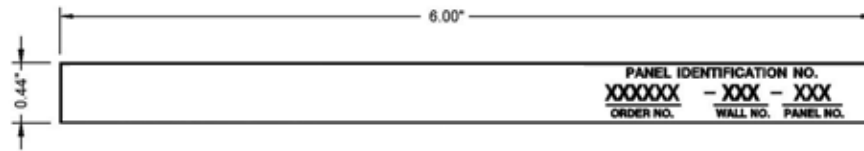

PANEL IDENTIFICATION LABEL

When calling for service to specific panels, please be prepared to give the panel identification no. of each panel that requires service.

As shown in the figure above, the PIN consists of three parts:

- ANC Order No. – This is Panelfold’s record number applicable to your project.
- Wall No. – This alpha-designation is different for each partition opening, and corresponds to the “ANC Wall Mark” as listed on the ANC “as built” shop drawings for the project.
- Panel No. – This number is different for each panel within a wall. Panel No.1 is the panel closest to the storage area/pocket (first to enter the storage area/pocket), and the other panels are numbered in ascending sequential order in a direction away from the storage area/pocket.

In the event that any panel identification label has been removed from its panel, a replacement label may be obtained by contacting ANC or your ANC distributor.

For the convenience of authorized service personnel working on the track or wheel carriers, each panel identification no. is also printed on a label adhered to the top of the panel. This label can be viewed by using a lift to get up to the track level and then looking down at the top end of the panel.

Lead and Trail Edges Defined

Each ANC operable wall panel has a designated lead edge and trail edge. As shown in the figures below, the lead edge is the edge that first leaves the storage area/pocket as the panel is being “Set Up”; the trail edge is the edge that first enters the storage area/pocket when the panel is being “Stored.”

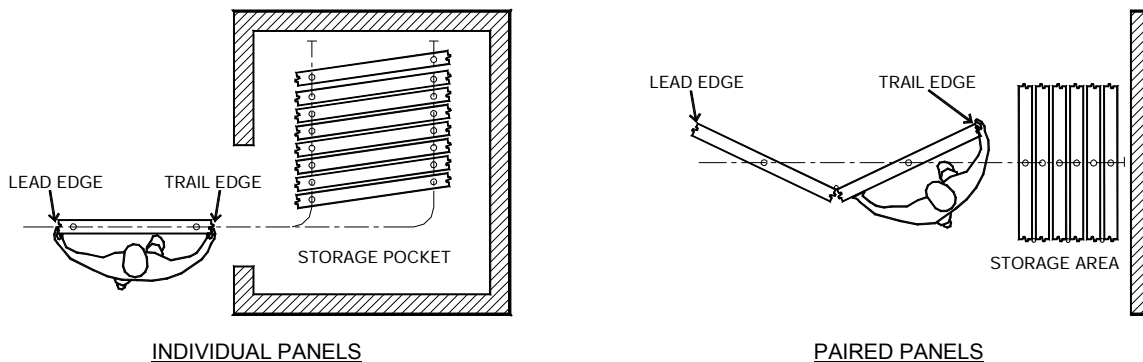

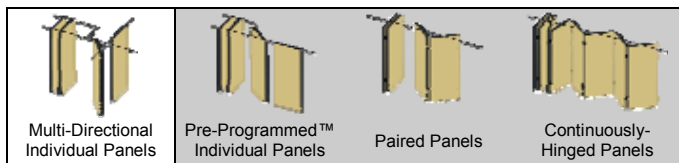

 **CAUTION:** Before attempting to move panels, be sure you have read and fully understand the “Rules For Safe Operation,” contained in this manual.

 Please also refer to “Sound Set Up Practices,” in this manual.

“Setting Up” Multi-Directional Panels

1. If the wall utilizes a storage pocket door, open it fully.
2. Make sure there are no obstacles along the track run that can block the movement of the panels.
3. Starting with the first panel out of the storage area/pocket, face the panel and take hold of both of its edges. Back up slowly, pulling the panel with you.
4. As the panel’s carrier(s) arrive into the middle of track intersections, slow the panel down and stop it. Take care to not slam panels into track intersections as this can cause possible damage to the panel’s carriers, track intersections and overhead structural support.
5. Ensure that the panel’s carrier(s) is (are) resting in the middle of the intersection(s) before you redirect and restart the panel’s movement.
6. When negotiating panels through track intersections, it is easiest to do so from the panel’s face, taking hold of both of the panel’s edges to control the panel’s redirection through the intersection.
7. After the panel has cleared the track intersection(s) and is on the main track, move around to the panel’s trail edge and begin pushing it to its “set-up” position.
8. If the panel arrives at another track intersection before reaching its “set up” position, repeat steps 4-7.
9. When the panel arrives at its “set up” position, slow the panel down as it nears engagement with the preceding panel or wall, so it does not slam into it. (Note: If the panel has Manuseals™, take the seal actuator tool with you as you move the panel across the room).
10. Make sure that the lead edge of the panel has properly engaged the trail edge of the preceding panel from top to bottom.
11. If the panel has Manuseals, while holding the panel firmly against the preceding panel, insert the seal actuator tool into the waist-height access hole located on the trail edge of the panel and rotate the tool clockwise 90° to extend the seals, then remove the seal actuator tool (See “Operating Manuseals”).
12. Return to the storage pocket and repeat steps 3-11 until all panels have been put in place.
13. Close the storage pocket door, if any.
14. Close the “final closure” panel(s). If the wall has:
 - a. Hinged closure panel(s), first, extend the floor bolt on the adjacent receptor panel, and then, swing closed the closure panel(s).
 - b. Expandable closure panel, extend its telescoping nose to seal against the adjacent jamb, panel or pocket door using the supplied actuator tool (See “Operating Expandable Closure Panels”).
15. Store the actuator tool, if any, in a secure location.

“Storing” Multi-Directional Panels

1. Open the “final closure” panel(s). If the wall has:
 - a. Hinged closure panel(s), first, swing open the closure panel(s), and then, retract the floor bolt on the adjacent receptor panel.
 - b. Expandable closure panel, retract its telescoping nose fully with the supplied actuator tool. (See “Operating Expandable Closure Panels”).
2. If the wall is intersected by expandable closure panel(s) in other wall(s), then retract the intersecting expandable closure panel(s) fully to allow free movement of the panels in the wall that is to be moved.
3. If the wall utilizes a storage pocket door, open it fully.
4. Starting with the panel nearest to the storage area/pocket:
 - a. If the panel has Manuseals™, insert the seal actuator tool into the waist-height access hole located on the “trail edge” of the panel and rotate the tool counterclockwise 180° to retract the seals, then remove the seal actuator tool (See “Operating Manuseals” and “Lead and Trail Edges Defined”).
5. Grab hold of the trail edge of the panel and pull it a short distance in the direction toward the storage area/pocket.
6. Once the panel is separated from the adjacent panel, move around to the other edge of the panel, taking hold of that edge, and push the panel at a walking pace along the main track.
7. As the panel’s carrier(s) arrive into the middle of track intersections, slow the panel down and stop it. Take care to not slam panels into track intersections as this can cause possible damage to the panel’s carriers, track intersections and overhead structural support.
8. Ensure that the panel’s carrier(s) is(are) resting in the middle of the intersection(s) before you redirect and restart the panel’s movement.
9. When negotiating panels through track intersections, it is easiest to do so from the panel’s face, taking hold of both of the panel’s edges to control the panel’s redirection through the intersection.
10. Once the panel turns into its track stack assembly, move around to its face and, grabbing both edges of the panel, continue pushing it all the way back into the stack. Take care not to slam stacked panels into each other.
11. Repeat steps 4-10 until all panels have been returned to the storage pocket.
12. Close the storage pocket door, if any.
13. Store the actuator tool, if any, in a secure location.

Operating Autoseals™

For those ANC operable walls that are equipped with operable bottom (or top) Autoseals, the seals automatically extend when the leading edge of a panel, or panel pair, is pushed against the trailing edge of the preceding panel, or panel pair, during “setting up” of the wall. Conversely, the Autoseals automatically retract when a panel, or panel pair, is pulled away from the preceding panel, or panel pair, during “storing” of the wall.

Each panel’s Autoseal(s) should be in the retracted position while the panel is being moved and when it is stored in the storage area/pocket. They should be in the extended position, engaging the floor (or track soffit), when the wall is “set up.”

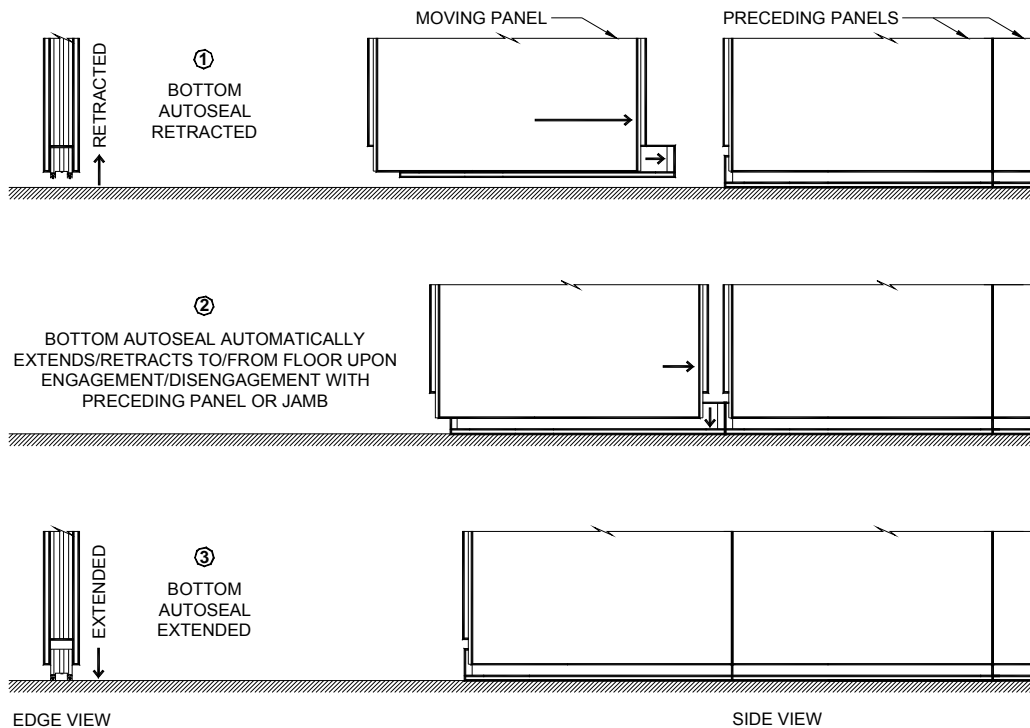

OPERATING AUTOSEALS™



ACOUSTICAL NOTE: To assure sound isolation between adjacent function rooms, it is important that all top and bottom seals are extended while the wall is “set up” for use. Even one seal left retracted will allow sound to stream from one room to the next.

Operating Manuseals™

For those ANC operable walls that are equipped with operable bottom Manuseals (and top Manuseals, where used), the seals are extended or retracted with use of the Universal Seal Actuator Tool that is shown in the figure below.

Each panel's Manuseals should be in the retracted position while the panel is being moved and when it is stored in the storage area/pocket. The bottom (and top) Manuseals should be in extended position when the wall is "set up."

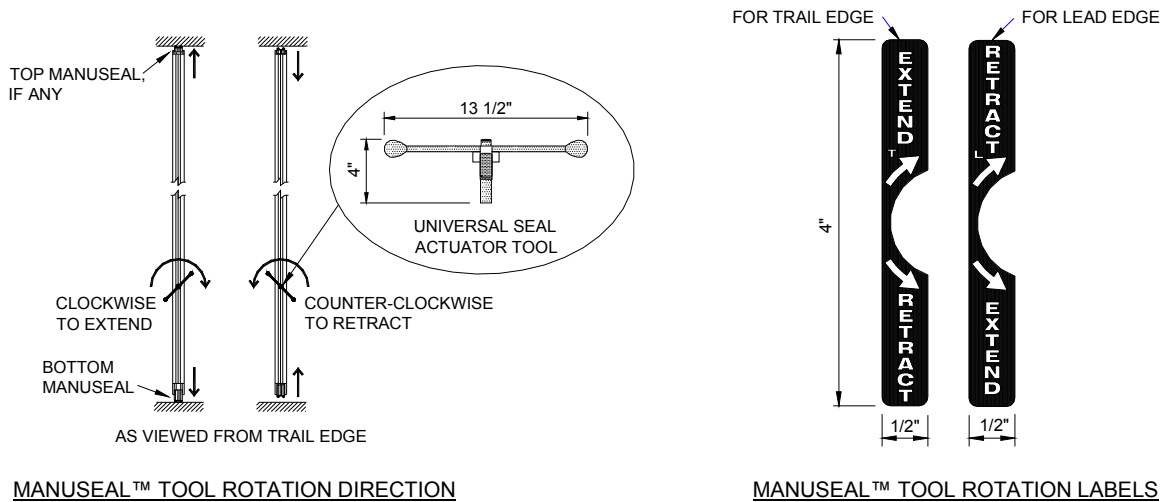

As shown in the Tool Rotation Direction figure above, to extend the bottom (and top) Manuseals, insert the seal actuator tool into the waist-height access hole on the trail edge of the panel and turn the tool clockwise approximately 90°, to release the cam-lock. This will allow the bottom Manuseal to extend until it contacts the floor (and the top Manuseal, if any, to simultaneously extend until it contacts the track soffit).

To retract the Manuseal(s), insert the seal actuator tool into the same waist-height access hole on the trail edge of the panel and turn the tool counterclockwise approximately 180°, until the seals cam-lock in their retracted position.

The lead and trail edge access holes are marked with labels, as shown in figure above, that show the correct direction of tool rotation. (See "Lead and Trail Edges Defined").

CAUTION: Never try to move a panel when the Manuseals are extended, as this will cause damage to the seal mechanisms.

ACOUSTICAL NOTE: To assure sound isolation between adjacent function rooms, it is important that all top and bottom seals are extended while the wall is "set up" for use. Even one seal left retracted will allow sound to stream from one room to the next.

NOTE: Each panel also has an access hole on its lead edge. However, the seals are typically actuated at the trail edge since the lead edge will be engaged against the preceding panel.

NOTE: Each Universal Seal Actuator Tool is supplied with a storage bracket so that the tool can be hung in a convenient, but secure, location (such as on an inside wall of a storage pocket) when the tool is not being used.

Operating Standard Expandable Panels

ANC operable walls that utilize expandable panels to effect final closure have, on one edge of the expandable panel, a full-height telescoping nose that utilizes gas springs and is easily actuated with the same universal seal actuator tool that actuates the wall's Manuseals™, if any.

To extend the telescoping nose, insert the seal actuator tool into the waist-height access hole that is located on either face of the expanding panel and turn the tool approximately 90°, to release the cam-lock. This will allow the expandable panel to extend until it contacts the jamb. Remove the actuator tool and store it in a secure location.

To retract the telescoping nose, insert the seal actuator tool into the waist-height access hole that is located on either face of the expandable panel and turn the tool approximately 180° until the telescoping nose cam-locks in its retracted position.

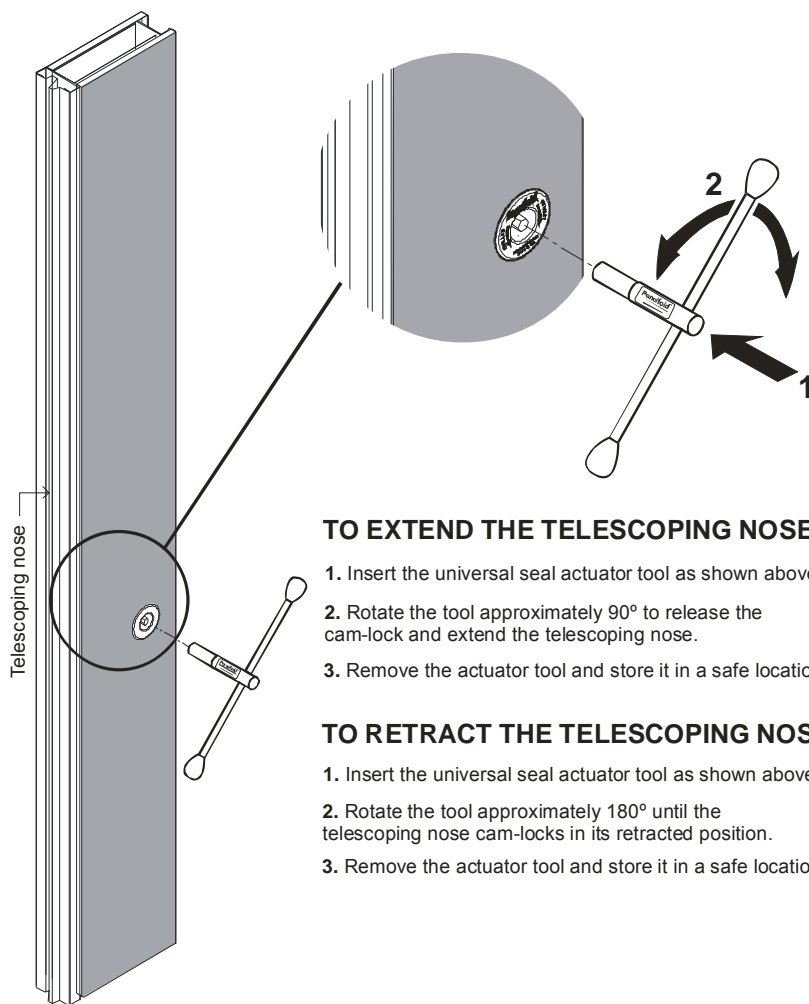

TO EXTEND THE TELESCOPING NOSE

1. Insert the universal seal actuator tool as shown above.
2. Rotate the tool approximately 90° to release the cam-lock and extend the telescoping nose.
3. Remove the actuator tool and store it in a safe location.

TO RETRACT THE TELESCOPING NOSE

1. Insert the universal seal actuator tool as shown above.
2. Rotate the tool approximately 180° until the telescoping nose cam-locks in its retracted position.
3. Remove the actuator tool and store it in a safe location.

OPERATING EXPANDABLE PANELS

CAUTION: When extending the telescoping nose of the expandable unit, never try to over-extend (over-rotate) the tool as this may cause damage to the internal mechanisms.

ACOUSTICAL NOTE: To assure sound isolation between adjacent function rooms, it is important that the telescoping nose of the expandable unit fully engages the jamb for a tight seal, from top to bottom. Otherwise, sound will stream from one room to the next.

Operating Standard Single Pass Door Panels

Each ANC single pass door panel consists of a swinging pass door that is hinged to a hinge leg and that closes to a strike leg, with the legs suspended from the bottom of a transom, as shown in the figure at right. The pass door panel's latching mechanism may be an ADA-compliant roller latch with hand-pulls, an ADA-compliant exit device with panic push bar or a non-compliant drop ring positive latch. A pass door panel may also be fitted with a key lock, exit sign, Autocloser™, push plate, kick plate, window or other option.

Each standard pass door panel has sweepseals on the bottom of the door and panel legs as well as a concealed floorbolt on each leg. It is important to extend the concealed floor bolt on each leg. Doing so will stabilize the panel, offsetting the cantilevered weight of a swung-open door, and help to assure that the door will swing open and closed with proper operating clearance. Conversely, during "storing" of the wall, the floor bolts must be retracted before the pass door panel can be moved to its storage area/pocket.

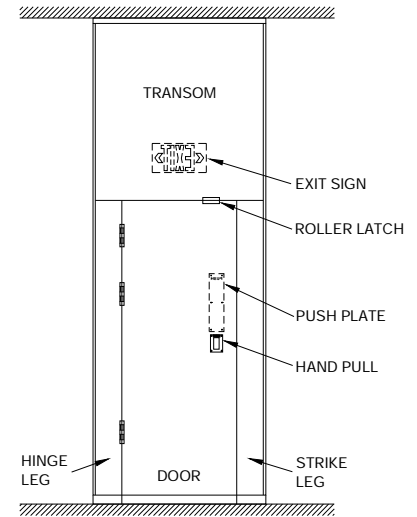

SINGLE PASS DOOR PANEL ↗

To "Set Up" a pass door panel, proceed as follows:

1. Move the pass door panel to its intended "set-up" position.
2. Apply pressure against the trail edge of the pass door panel so that its lead edge tightly engages the trail edge of the preceding panel.
3. Extend the floorbolt located on the trail edge (outside edge) of the trail leg of the pass door panel until it engages the hole in its receptor floor plate (see note below).
4. Extend the floorbolt located on the trail edge (inside edge) of the lead leg of the pass door panel until it engages the hole in its receptor floor plate.
5. Close the door.

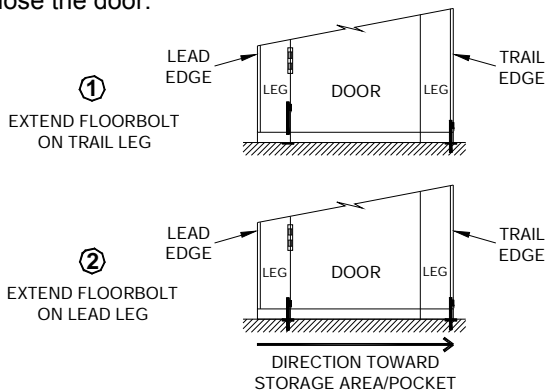

EXTENDING THE PASS DOOR FLOORBolTS

To "Store" a pass door panel, proceed as follows:

1. Open the door and raise the floorbolt located on the trail edge (inside edge) of the lead leg.
2. Close the door.
3. Raise the floorbolt located on the trail edge (outside edge) of the trail leg (see note below).
4. Be sure that the floorbolts are retracted fully so that they will not drag on the floor when the panel is being moved.
5. Move the pass door panel to its storage area/pocket.

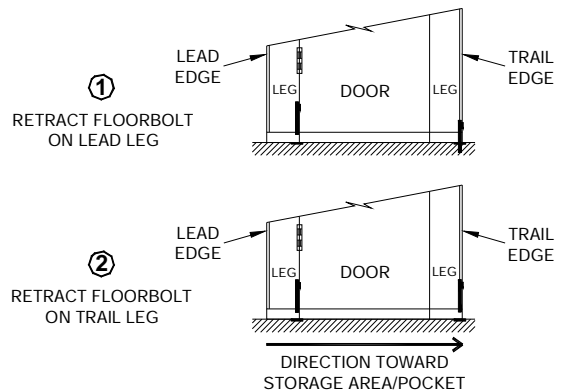

RETRACTING THE PASS DOOR FLOORBolTS

NOTE: If the pass door is located in the lead panel of a hinged-together pair of panels, the trail leg's floorbolt will be located on its inside edge rather than its outside edge.

ACOUSTICAL NOTE: The sweepseals on both the door and panel legs should engage the floor with a "light touch" when the panel is located in its "set up" position. If the bottom sweepseals are not touching the floor surface when the operable wall is "set up," this will result in sound streaming under the door from one room to the next. On the other hand, if the bottom sweepseals engage the floor too firmly, this will make it difficult for the door to be opened and closed. If either of these conditions are present, please refer to "Adjusting Bottom Sweepseals" in this manual.

Operating Standard Double Pass Door Panels

Each ANC double pass door panel consists of a swinging pass door that is hinged to a hinge leg and that closes to the strike edge of the adjacent door. The hinge legs are suspended from the bottom of a transom, as shown in the figure at right. The pass door panel's latching mechanism may be an ADA-compliant roller latch with hand-pulls and Travelock™ or an ADA-compliant exit device with panic push bar. A pass door panel may also be fitted with a key lock, exit sign, Autocloser™, push plate, kick plate, window or other option.

Each standard pass door panel has sweepseals on the bottom of the door and panel leg as well as a concealed floorbolt on the leg. It is important to extend the concealed floor bolt. Doing so will stabilize the panel, offsetting the cantilevered weight of a swung-open door, and help to assure that the door will swing open and closed with proper operating clearance. Conversely, during "storing" of the wall, the floor bolt must be retracted before the pass door panel can be moved to its storage area/pocket.

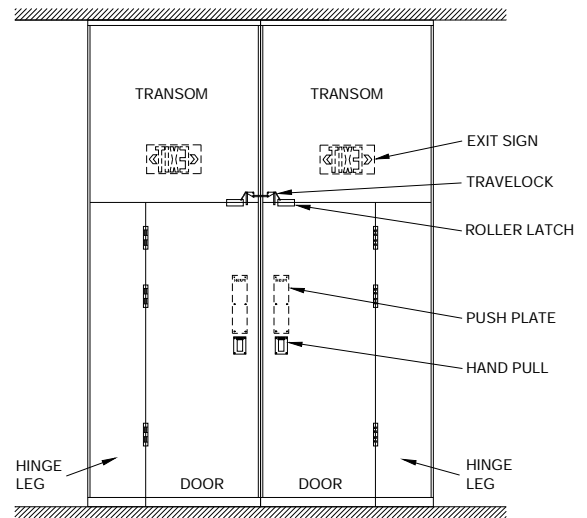

DOUBLE PASS DOOR PANELS ↗

To "Set Up" double pass door panels, proceed as follows:

1. Move each pass door panel to its intended "set up" position.
2. Apply pressure against the trail edge of the trail pass door panel so that its lead edge tightly engages the trail edge of the lead pass door panel (See ▲ CAUTION below).
3. Extend the floorbolt located on the trail edge (outside edge) of the trail leg until it engages the hole in its receptor floor plate.
4. Open the lead panel's pass door and extend the floorbolt located on the trail edge (inside edge) of the lead leg until it engages the hole in its receptor floor plate.
5. Check to be sure that both doors open and close normally (See ▲ CAUTION below).

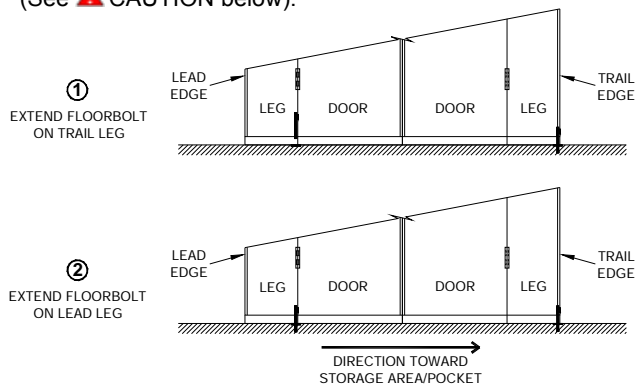

EXTENDING THE PASS DOOR FLOORBOLTS

To "Store" double pass door panels, proceed as follows:

1. Open the lead panel's pass door and raise the floorbolt located on the trail edge (inside edge) of the lead leg.
2. Close the door.
3. Raise the floorbolt located on the trail edge (outside edge) of the trail leg.
4. Be sure that the floorbolts are retracted fully so that they will not drag on the floor when the panels are being moved.
5. Move each pass door panel to its storage area/pocket.

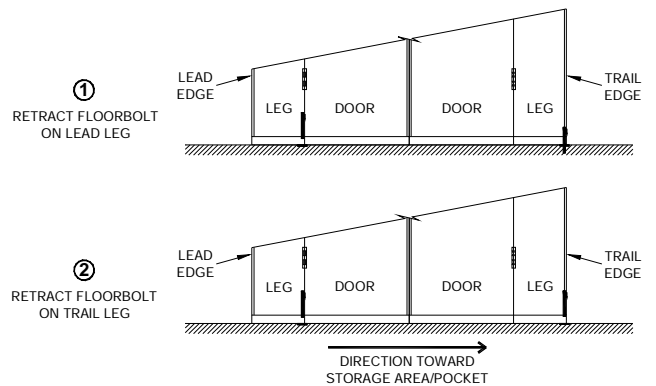

RETRACTING THE PASS DOOR FLOORBOLTS

▲ CAUTION: Each double pass door panel includes a Travelock™ that automatically locks its swinging door in the closed position to prevent it from swinging open while the panel is being moved between its "stored" and "set up" positions. The Travelocks™ automatically disengage, allowing the doors to be opened, when the two adjacent pass door panels are pressed tightly against each other in their "set up" positions. When the wall is "set up" never allow the two panels to separate from each other, as this would cause the doors to become unintentionally locked closed.

🔊 ACOUSTICAL NOTE: The sweepseals on both the door and panel legs should engage the floor with a "light touch" when the panel is located in its "set up" position. If the bottom sweepseals are not touching the floor surface when the operable wall is "set up," this will result in sound streaming under the door from one room to the next. On the other hand, if the bottom sweepseals engage the floor too firmly, this will make it difficult for the door to be opened and closed. If either of these conditions are present, please refer to "Adjusting Bottom Sweepseals," in this manual.

Operating Deluxe Single Pass Door Panels

Each ANC single pass door panel consists of a swinging pass door that is hinged to a hinge leg and that closes to a strike leg, with the legs suspended from the bottom of a transom, as shown in the figure at right. The pass door panel's latching mechanism may be an ADA-compliant roller latch with hand-pulls, an ADA-compliant exit device with panic push bar or a non-compliant drop ring positive latch. A pass door panel may also be fitted with a key lock, exit sign, Autocloser™, push plate, kick plate, window or other option. Each deluxe pass door panel includes an operable Manuseal™ on the bottom of each leg and on the bottom of the swinging door (and an operable seal on the top of the panel, if ordered).

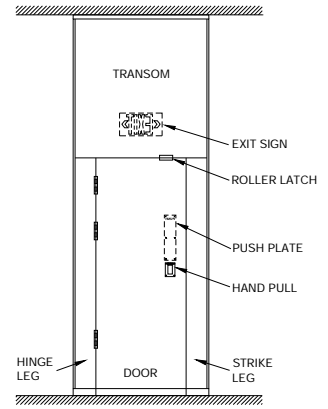

SINGLE PASS DOOR PANEL ↗

To "Set Up" a pass door panel, proceed as follows:

1. Move the pass door panel to its intended "set-up" position.
2. Apply pressure against the trail edge of the pass door panel so that its lead edge tightly engages the trail edge of the preceding panel.
3. Insert the seal actuator tool into the waist-height access hole located on the trail edge (outside edge) of the trail leg of the pass door panel, and rotate the tool clockwise approximately 90°. This will extend the bottom Manuseal that is on the trail leg (and will partially extend the panel's top Manuseal, if any).
4. Open the door and insert the seal actuator tool into the waist-height access hole located on the trail edge (inside edge) of the lead leg and turn the tool clockwise 90°. This will extend the bottom Manuseal that is on the lead leg (and will finish extending the panel's top Manuseal, if any).
5. While the door is opened insert the actuator tool into the waist-height access hole located on the strike edge (non-hinged edge) of the door itself. Rotate the tool in the direction indicated by the label to extend the bottom Manuseal on the door until it contacts the floor.

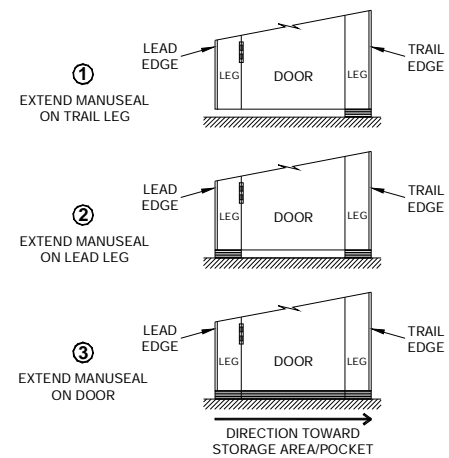

EXTENDING THE PASS DOOR MANUSEALS

To "Store" a pass door panel, proceed as follows:

1. Open the pass door and insert the seal actuator tool into the waist-height access hole on the strike edge (non-hinged edge) of the door itself. Rotate the tool 180° in the direction indicated by the label to retract the bottom Manuseal on the door.
2. While the door is open, insert the seal actuator tool into the waist-height access hole located on the trail edge (inside edge) of the lead leg and turn the tool counterclockwise 180°. This will retract the bottom Manuseal on the lead leg (and will partially retract the panel's top Manuseal, if any).
3. Close the door.
4. Insert the seal actuator tool into the waist-height access hole on the trail edge (outside edge) of the trail leg and turn the tool counterclockwise 180°. This will retract the bottom seal on the trail leg (and will finish retracting the panel's top Manuseal, if any).
5. Move the pass door panel to its storage area/pocket.

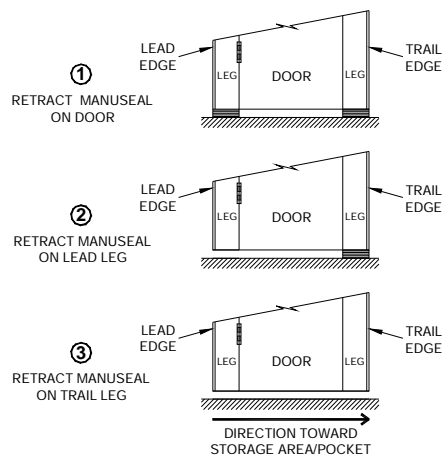

RETRACTING THE PASS DOOR MANUSEALS



ACOUSTICAL NOTE: If the bottom sweepseals on the door are not touching the floor surface when the operable wall is "set up," this will result in sound streaming under the door from one room to the next. On the other hand, if the bottom sweepseals engage the floor too firmly, this will make it difficult for the door to be opened and closed. If either of these conditions are present, refer to "Adjusting the Pass Door Seal Extension Limiter".

Operating Deluxe Double Pass Door Panels

Each ANC double pass door panel consists of a swinging pass door that is hinged to a hinge leg and that closes to the strike edge of the adjacent door. The hinge legs are suspended from the bottom of a transom, as shown in the figure at right. The pass door panel's latching mechanism may be an ADA-compliant roller latch with hand-pulls and Travelock™ or an ADA-compliant exit device with panic push bar. A pass door panel may also be fitted with an exit sign, Autocloser™, push plate, kick plate, window or other option.

Each deluxe pass door panel includes an operable Manuseal™ on the bottom of its hinge leg and on the bottom of the swinging door (and an operable seal on the top of the panel, if ordered).

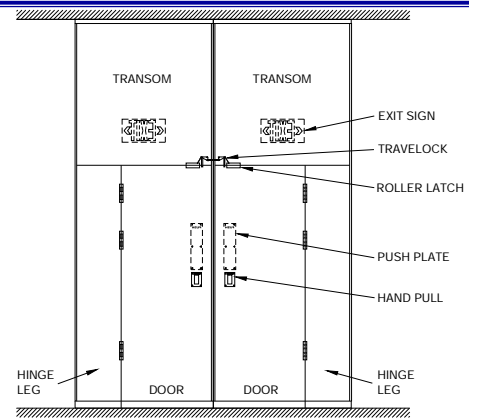

DOUBLE PASS DOOR PANELS ↗

To "Set Up" double pass door panels, proceed as follows:

1. Move each pass door panel to its intended "set-up" position.
2. Apply pressure against the trail edge of the trail pass door panel so that its lead edge tightly engages the trail edge of the lead pass door panel (See ▲ CAUTION below).
3. Insert the seal actuator tool into the waist-height access hole located on the trail edge (outside edge) of the trail leg, and rotate the tool clockwise approximately 90°. This will extend the bottom Manuseal that is on the trail leg (and will extend the trail panel's top Manuseal, if any).
4. Open the lead panel's door and insert the seal actuator tool into the waist-height access hole located on the trail edge (inside edge) of the lead leg and turn the tool clockwise 90°. This will extend the bottom Manuseal on the lead leg (and will extend the lead panel's top Manuseal, if any).
5. While the door is opened insert the actuator tool into the waist-height access hole located on the strike edge (non-hinged edge) of each swinging door. Rotate the tool in the direction indicated by the label to extend the bottom Manuseal on each door until it contacts the floor.
6. Check to be sure that both doors open and close normally (See ▲ CAUTION below).

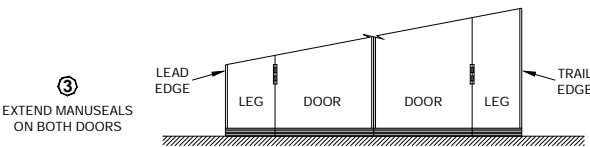
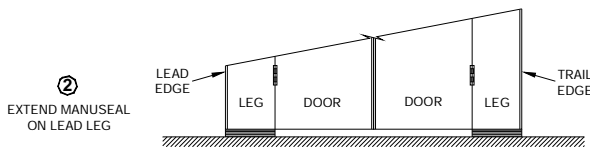
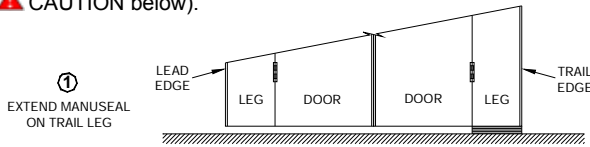

EXTENDING THE PASS DOOR MANUSEALS

To "Store" double pass door panels, proceed as follows:

1. Open the lead panel's pass door and insert the seal actuator tool into the waist-height access hole on the strike edge (non-hinged edge) of each swinging door. Rotate the tool 180° in the direction indicated by the label to retract the bottom Manuseal on each door.
2. While the lead panel's door is open, insert the seal actuator tool into the waist-height access hole located on the trail edge (inside edge) of the lead leg and turn the tool counterclockwise 180°. This will retract the bottom Manuseal on the lead leg (and will retract the lead panel's top Manuseal, if any).
3. Close the door.
4. Insert the seal actuator tool into the waist-height access hole on the trail edge (outside edge) of the trail leg and turn the tool counterclockwise 180°. This will retract the bottom seal on the trail leg (and will retract the trail panel's top Manuseal, if any).
5. Move each pass door panel to its storage area/pocket.

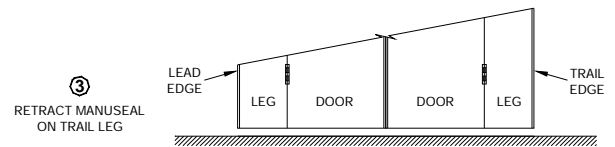
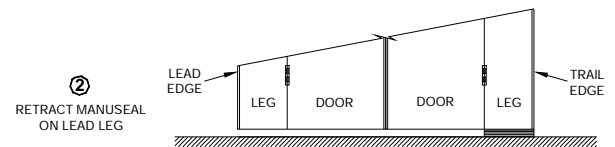
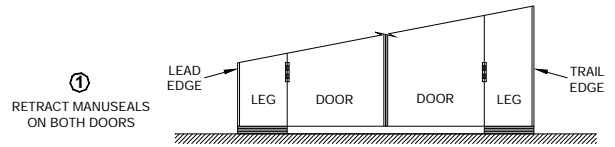

RETRACTING THE PASS DOOR MANUSEALS

▲ CAUTION: Each double pass door panel includes a Travelock™ that automatically locks its swinging door in the closed position to prevent it from swinging open while the panel is being moved between its "stored" and "set up" positions. The Travelocks™ automatically disengage, allowing the doors to be opened, when the two adjacent pass door panels are pressed tightly against each other in their "set up" positions. When the wall is "set up" never allow the two panels to separate from each other, as this would cause the doors to become unintentionally locked closed.

ACOUSTICAL NOTE: If the bottom sweepseals on the door are not touching the floor surface when the operable wall is "set up," this will result in sound streaming under the door from one room to the next. On the other hand, if the bottom sweepseals engage the floor too firmly, this will make it difficult for the door to be opened and closed. If either of these conditions are present, refer to "Adjusting the Pass Door Seal Extension Limiter".

Operating Single, Double and Bi-Fold Pocket Doors

Some ANC operable walls, when not in their “set up” position, are stored in a storage “pocket” (storage closet) that is closed by a ANC single, double or bi-fold pocket door as shown below. The pocket door may be fitted with a key lock.

If the trail panel of the operable wall is an expandable panel designed to acoustically seal against the face of the pocket door, the door must be closed, and its floorbolt and soffit bolt must be extended, prior to extending the telescoping nose of the expandable panel. If the floor and soffit bolts are not properly engaging the holes in their receiving plates, the expandable panel will not seal tightly, from top to bottom, to the face of the pocket door, which may allow sound to stream from room to room.

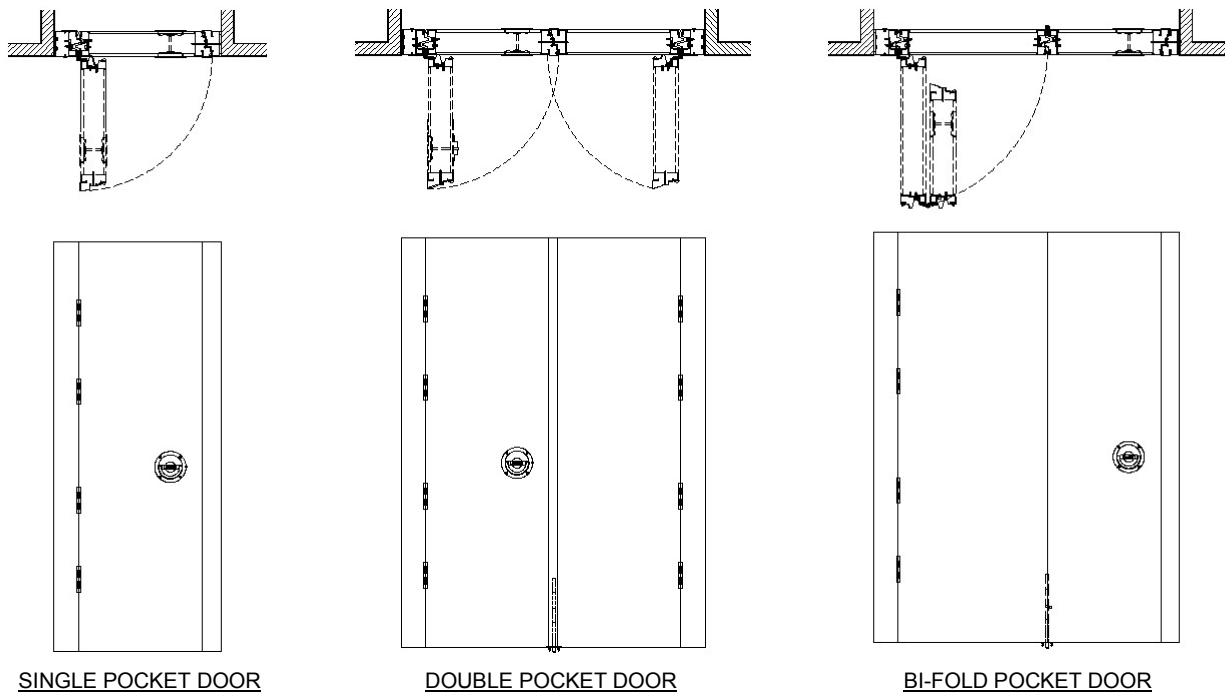

SINGLE POCKET DOOR

DOUBLE POCKET DOOR

BI-FOLD POCKET DOOR

▲ CAUTION: Before returning each panel to its storage area (storage closet), inspect the interior of the area (pocket) to be sure that nothing has been stored in the vacant area (pocket) and that there is no one in the area (pocket) that could be hit or trapped by the panel.

▲ CAUTION: Before closing and/or locking pocket doors, be sure that there is no one in the pocket.

Operating 3-Section Pocket Doors

Some Panelfold operable walls, when not in their “set up” position, are stored in a storage “pocket” (storage closet) that is closed by a ANC 3-section pocket door as shown below. The pocket door may be fitted with a key lock.

A 3-section pocket door is typically used when the operable wall acoustically seals to the back of the pocket. In this case, the center section of the door is designed to be left open, and the other two sections closed, when the wall is in its “set up” position.

However, in some cases, a 3-section pocket door is used when the trail panel of the operable wall is an expandable panel designed to acoustically seal against the face of the pocket door. In this case, all three sections of the door must be closed, and its floorbolt and soffit bolt must be extended, prior to extending the telescoping nose of the expandable panel. If the floor and soffit bolts are not properly engaging the holes in their receiving plates, the expandable panel will not seal tightly, from top to bottom, to the face of the pocket door, which may allow sound to stream from room to room.

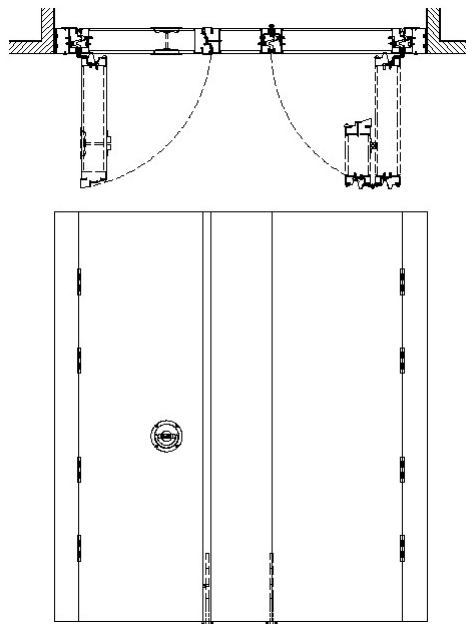

3-SECTION POCKET DOOR

⚠ CAUTION: Before returning each panel to its storage area (storage closet), inspect the interior of the area (pocket) to be sure that nothing has been stored in the vacant area (pocket) and that there is no one in the area (pocket) that could be hit or trapped by the panel.

⚠ CAUTION: Before closing and/or locking pocket doors, be sure that there is no one in the pocket.

Operating Double Pocket Doors with Slot Closures

Some ANC operable walls, when not in their “set up” position, are stored in a storage “pocket” (storage closet) that is closed by a ANC pocket door. A “Double Pocket Door with Slot Closures” is designed to seal against the faces of the trail panel (last panel out of the pocket), when the wall is “set up,” as shown in the figure below. The pocket door may be fitted with a keyed deadlock and/or a keyed locking floorbolt.

To remove an operable wall from its storage pocket and seal the pocket doors to the extended wall, proceed as follows:

1. Unlock the keyed deadlock located on the right-side slot closure, if any, and pull open the right-side slot closure.
2. Raise the floorbolt that is on the edge of the left-side slot closure and pull open the left-side slot closure.
3. Raise the floorbolts that are on the edges of the left-side and right-side doors and open both pocket doors fully to provide access to the pocket.
4. Move the operable wall panels to their “set up” positions. The last panel out of the pocket will acoustically seal through the pocket door slot.
5. After extending the top and bottom seals of the last traveling panel, lower the panel holder that is on its trail edge until it engages the floor carpet or 6” x 10” slip-resistant surface adhered to the storage pocket floor. This will prevent the trail panel from receding into the pocket when the slot closures are pressed against the panel.
6. Close both pocket doors. To close the first door, go into the pocket and pull on the padded strap handle until the door is fully closed and the soft seal on its slot closure is engaged tightly to the face of the trail panel. Then, exit the pocket and push on the face of the second door until it is fully closed and the soft seal on its slot closure is engaged tightly to the other face of the trail panel.
7. If the pocket has an auxiliary access door, you may secure the pocket by extending the floorbolts that are on the edges of the left-side and right-side doors, and then exiting the pocket through the access door. If the pocket does not have an auxiliary door, you may secure the pocket by extending the floorbolt that is on the edge of the left-side door, and then exiting the pocket through the right-side door before extending its locking floorbolt, if any.

To return the operable wall panels to their storage pocket and close the pocket doors, proceed as follows:

1. Open both pocket doors fully.
2. Lift the panel holder and retract the top and bottom seals on the trail panel (the panel that had been sealed through the pocket slot) and move the panel to its stored position.
3. Move all the remaining panels into their stored positions in the storage pocket.
4. Close the left-side pocket door and extend the floorbolt that is on its edge.
5. Close the right-side pocket door and extend the floorbolt that is on its edge.
6. Close the left-side slot closure and extend the floorbolt that is on its edge.
7. Close the right-side slot closure and lock the keyed deadlock, if any.

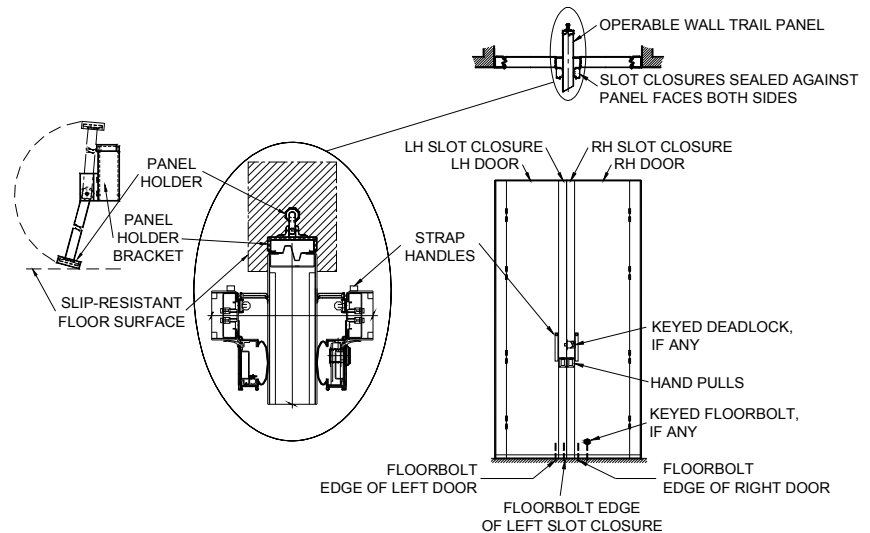

DOUBLE POCKET DOOR WITH SLOT CLOSURES



ACOUSTICAL NOTE: To provide effective sound isolation between adjacent rooms, it is important that the slot closures' soft seals are firmly and tightly engaging both faces of the operable wall panel.



NOTE: If the floor is not carpeted at the position of the trail panel's holder, a 6” x 10” slip-resistant surface may have been adhered to the floor. The material may need to be replaced from time to time, if it becomes worn or loses traction. 3M™ Safety-Walk™, which is marketed for stair treads, or any similar material may be used so long as it provides traction for the panel holder. Follow the surface preparation and application instructions furnished with the 3M™ or other slip-resistant material selected.



CAUTION: Before returning each panel to its storage area (storage closet), inspect the interior of the area (pocket) to be sure that nothing has been stored in the vacant area (pocket) and that there is no one in the area (pocket) that could be hit or trapped by the panel.



CAUTION: Before closing and/or locking pocket doors, be sure that there is no one in the pocket.

Operating Pocket Slot Closures

Some ANC operable walls, when not in their “set up” position, are stored in a storage “pocket” (storage closet) that utilizes a ANC Pocket Slot Closure. “Pocket Slot Closures” are designed to seal against the face of the trail panel (last panel out of the pocket), when the wall is “set up,” as shown in the figure below.

To remove an operable wall from its storage pocket and seal the pocket slot closures to the extended wall, proceed as follows:

1. Unlock the keyed deadlock located on the right-side slot closure, if any, and pull open the right-side slot closure.
2. Raise the floorbolt that is on the edge of the left-side slot closure and pull open the left-side slot closure.
3. Enter the storage pocket through the access door and move the operable wall panels through the pocket slot and to their “set up” positions. The last panel out of the pocket will acoustically seal through the pocket slot.
4. After extending the top and bottom seals of the last traveling panel, lower the panel holder that is on its trail edge until it engages the floor carpet or 6” x 10” slip-resistant surface adhered to the storage pocket floor. This will prevent the trail panel from receding into the pocket when the slot closures are pressed against the panel.
5. Close both slot closures. To close the first slot closure go into one room and push on the hinged slot closure until it engages tightly to the face of the trail panel. Then, go into the other room and push on the hinged slot closure until it engages tightly to the face of the trail panel.

To return the operable wall panels to their storage pocket and close the pocket slot closers, proceed as follows:

1. Open both pocket slot closures fully.
2. Lift the panel holder, retract the top and bottom seals on the trail panel (the panel that had been sealed through the pocket slot) and move the panel to its stored position.
3. Move all the remaining panels into their stored positions in the storage pocket.
4. Close the left-side slot closure and extend the floorbolt that is on its edge.
5. Close the right-side slot closure and lock the keyed deadbolt, if any.

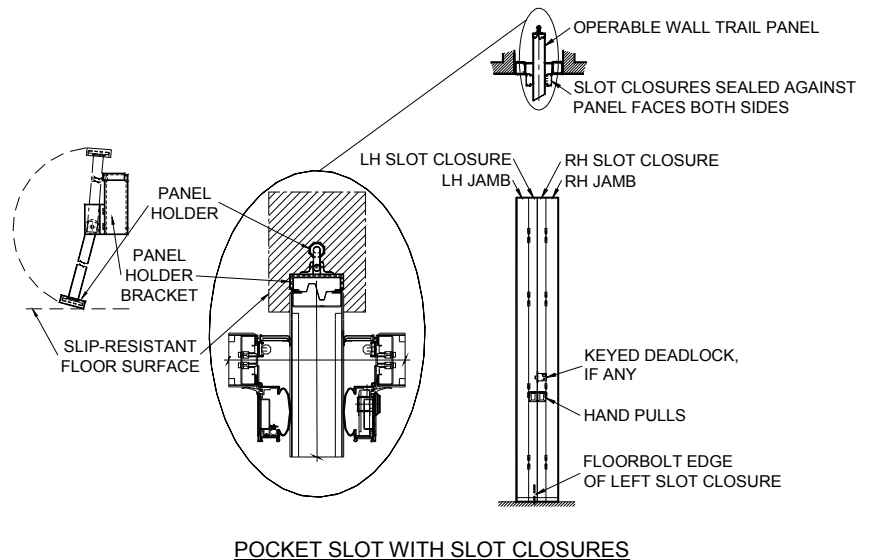

 **ACOUSTICAL NOTE:** To provide effective sound isolation between adjacent rooms, it is important that the slot closures’ soft seals are firmly and tightly engaging both faces of the operable wall panel.

 **NOTE:** It is not necessary to set the floorbolt when an operable wall panel is sealed through the pocket door slot. The floorbolt is used to secure the slot closures when the operable wall panels are stored in the pocket.

 **NOTE:** If the floor is not carpeted at the position of the trail panel’s holder, a 6” x 10” slip-resistant surface may have been adhered to the floor. The material may need to be replaced from time to time, if it becomes worn or loses traction. 3M™ Safety-Walk™, which is marketed for stair treads, or any similar material may be used so long as it provides traction for the panel holder. Follow the surface preparation and application instructions furnished with the 3M™ or other slip-resistant material selected.

 **CAUTION:** Before returning each panel to its storage area (storage closet), inspect the interior of the area (pocket) to be sure that nothing has been stored in the vacant area (pocket) and that there is no one in the area (pocket) that could be hit or trapped by the panel.

 **CAUTION:** Before closing and/or locking slot closures or pocket access doors, be sure that there is no one in the pocket.

Adjusting a Deluxe Pass Door's Seal Extension Limiter

Each ANC pass door panel that is equipped with bottom Manuseals™ includes, on the swing-ing door, a seal extension limiter that was adjusted at the time of installation so that the bottom sweepseals on the swinging door, when extended, lightly touch the floor surface. The sweepseals, when extended, should engage the floor surface sufficiently to form an acoustical seal but lightly enough to allow the door to be swung open and closed without excessive effort or binding.

The seal extension limiter may be re-adjusted with the use of a no. 2 phillips screwdriver, as follows:

1. Move the pass door panel to its intended "set up" position.
2. Using the seal actuator tool, extend the bottom seals on both legs of the pass door panel.
3. Swing open the pass door fully.
4. Extend the bottom seal on the door.
5. Find the ½" diameter hole that is located on each edge of the door, approximately 18" above the bottom of the door.
6. Insert a no. 2 phillips screwdriver into the hole on one edge of the door until it engages the screw that is located behind the hole. Turn the screw counterclockwise slightly, just enough to loosen it. (Do not remove it.)
7. Repeat the process for the screw on the other edge of the door.
8. Place a 1-½" high x 1" wide x 6" long wood block under each end of the hard bottom of the door's bottom seal and between the flexible sweepseals. This should leave the sweepseals lightly engaging the floor surface.
9. Using the phillips screwdriver, re-tighten the screws on both edges of the door.
10. Using the seal actuator tool, retract the floor seal on the door.
11. Remove the wood blocks and store them for future use.
12. Using the seal actuator tool, retract and then re-extend the bottom seal on the door to be sure that the seal is retracting and extending properly and that the sweepseals are engaging the floor surface with the desired "light touch."

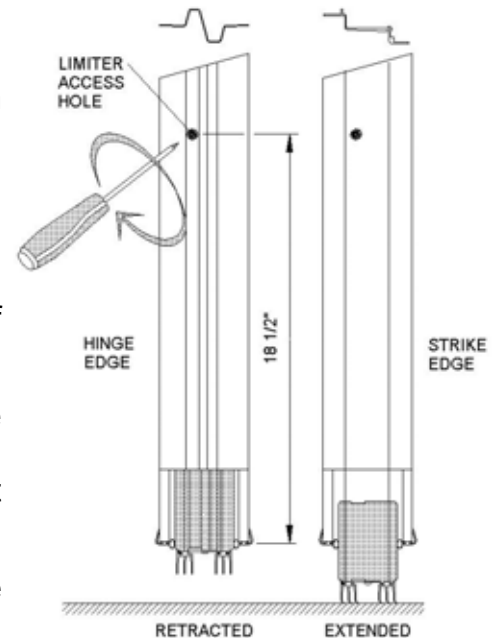

ADJUSTING THE PASS DOOR SEAL EXTENSION LIMITER

Adjusting a Pass Door's Legs

For each pass door to operate freely, and yet close fully and tightly for acoustical purposes, the strike edge of the door must be in vertical alignment with the strike leg to which it engages. If the gap between the door and the leg is too small at either top or bottom, the door may bind. If the gap is too large, sound may stream through the gap.

Panelfold pass door panels are designed to allow the door and legs to be adjusted by an authorized ANC service technician. If the strike leg is out of plumb, it should be adjusted. If the pass door is out of plumb, the hinge leg to which it is hinged should be adjusted. In brief, the procedure is as follows:

1. Remove the steel astragal from the outer edge of the panel edge that is to be adjusted.
2. Remove the aluminum header trim from the bottom of the transom.
3. Loosen, but do not remove, the bolts that join the leg to the transom at their outer edge.
4. Loosen, but do not remove, the bolts that join the leg to the bottom of the transom.
5. Turn the two allen-head set screws clockwise, in order to toe the bottom of the leg outward, or counterclockwise, to toe the bottom of the leg inward.
6. Re-tighten the bolts that join the leg to the bottom of the transom.
7. Check to be sure the strike edge of the door and leg are aligned and that the door closes freely and fully.
8. Re-tighten all of the bolts that had been loosened.
9. Re-secure the aluminum header trim to the bottom of the transom.
10. Re-secure the steel astragal to the outer edge of the panel.

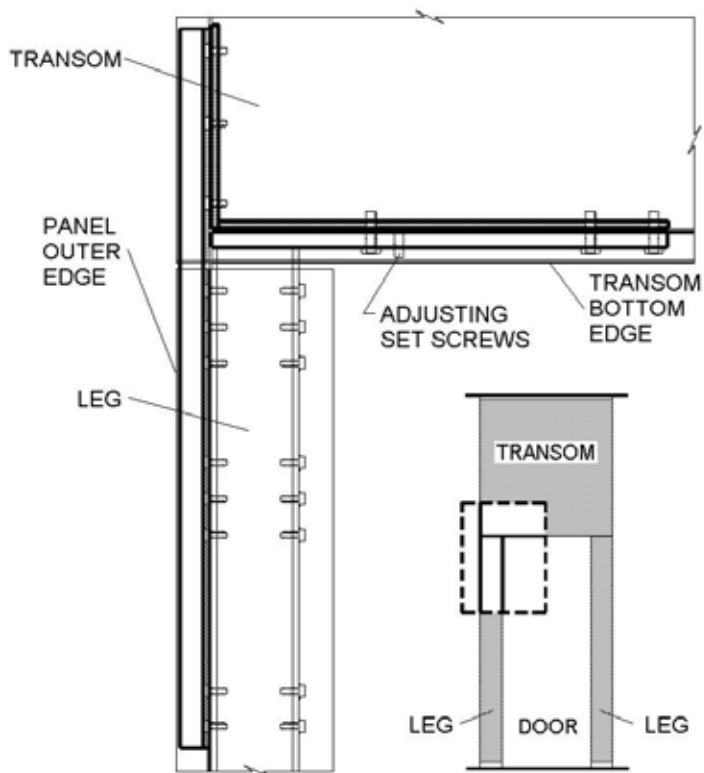

ADJUSTING A PASS DOOR'S LEGS

i NOTE: ANC recommends that the above adjustments be attempted only by an authorized ANC service technician.

i NOTE: Over the years, due to the impact of carts, food service equipment or the like, a pass door panel's door and/or legs may become damaged. The ANC design allows the door and/or legs to be replaced without having to replace the entire panel.

Adjusting Bottom Sweepseals

Although most panels, or panel pairs, typically have bottom clearance-type Autoseals™, Manuseals™ or floating seals, a few of the panels (such as hinged or expandable closure panels, standard pass door panels and pocket doors) may be fitted with bottom fixed sweepseals.

Each extruded vinyl sweepseal has three “fingers” that should engage the floor with a “light touch,” i.e. so that the tips of the fingers over-engage the floor, or curl, by about 1/8”.

Each sweepseal “finger” contains striations to allow the sweepseal to be easily trimmed shorter, if needed. Typically, such trimming, if any, would have been done at the time of initial installation. However, occasionally, due, for example, to building settling/deflection or installation of thicker floor covering, it may be necessary to trim the sweepseals.

Inspecting the sweepseals for fit:

Before trimming a panel’s bottom sweepseals, inspect the panel in its “set up” closed position. Check to be sure that the panel’s top sweepseals are engaging the track soffit with a “light touch.”

If the top sweepseals are not engaging the soffit, this will cause a sound leak and the panel may need to be raised by adjusting its trolley suspension bolt(s). If the top sweepseals are engaging the soffit too tightly, causing the panel to be too hard to move, then the panel may need to be lowered by adjusting its trolley suspension bolt(s).

In either case, the bottom sweepseals should not be trimmed unless the panel is plumb and the top sweepseals are properly engaging the soffit with a “light touch.”

▲ CAUTION: Adjustment of trolley suspension bolts should only be performed by an authorized ANC service technician. (See “Rules for Safe operation” and “Suspension Locking Plates”).

Trimming the sweepseals:

If the panel is plumb, the top seal engagement is correct, and the bottom seal is over-engaging the floor at its “set up,” in-use position, then the bottom sweepseals may be trimmed as follows:

1. Using scissors or a knife, cut an approximately 1/2” long, horizontal slit into one of the striations (thin grooves) at one end of one of the three sweepseal “fingers.” Then, grasp the slit portion and pull it, to “strip off” the rest of it along the full length of the sweepseal.
2. Repeat step 1 for each sweepseal “finger” that needs to be shortened, until each finger engages the floor with a “light touch.”

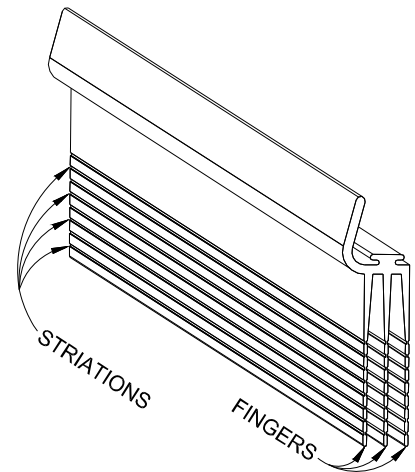

SWEEPSEAL

Suspension Locking Plates

ANC operable wall panels are suspended from trolleys that are attached to the panel by a threaded suspension bolt that is fitted with a locking plate of one of the types shown below.

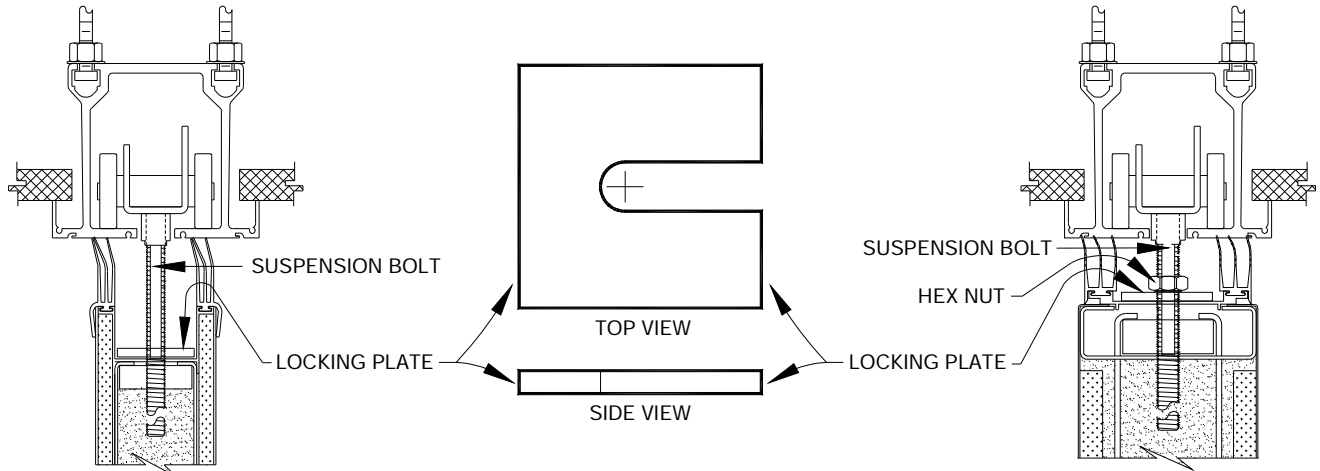

LOCKING PLATE INSTALLED ON PANEL THAT HAS TOP SWEEPSEALS

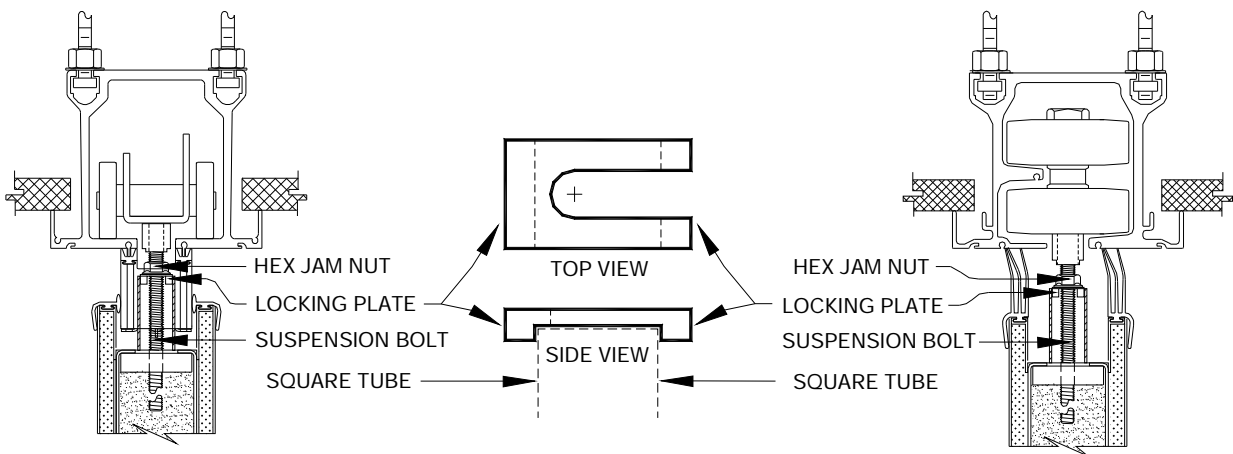

LOCKING PLATE INSTALLED ON PANEL THAT HAS A TOP OPERABLE SEAL AND/OR THAT HAS MULTI-DIRECTIONAL WHEELS



CAUTION: LOCKING PLATES MUST NEVER BE REMOVED, except by an authorized ANC service technician, and, then, only momentarily while adjusting the elevation or plumb of a panel. Moving a panel with a locking plate removed may result in the suspension bolt unthreading from the panel, causing the panel to fall.

GENERAL MAINTENANCE

Maintaining Panel Surfaces

Vinyl Wall Covering, High Pressure Laminate and Wood Veneer

- To clean, dampen a cloth with warm, soapy water and scrub the area to be cleaned. Rinse and dry the surface afterward. If stains persist, try a non-solvent, foaming cleaner or other mild spray cleaner. Avoid using abrasive cleaners.

Fabric and Carpet

- These wall coverings will stay attractive and serviceable with regular vacuuming.
- Carefully blot liquid spills immediately with a dry, white, absorbent cloth or paper towel. Avoid scrubbing the area. This may distort the pile. To prevent spreading, work from the edges of the stain to the center.
- Most stains will disappear when treated with a mild detergent. After the stain has been removed, rinse with a mist sprayer of cold water and blot until dry.
- For solids, allow to dry, remove with a wet cloth, gently brush and vacuum.
- If you elect to use a cleaning solvent or spot removal agent, test in an inconspicuous area to make certain the solution does not alter color, damage fiber or attack the contact adhesive that was used to laminate the wall carpeting to the panel faces.
- Immediate attention to any spill will increase the probability of removal.
- Repeating the steps: wet-wipe-rinse-blot dry, may be required to fully extract contaminant.
- For most cleaners, rinse with a mist sprayer of cold water to prevent residue of cleaning solution from attracting future soil.

Maintaining Track and Trolleys

The inside wheel riding surfaces of the operable wall tracks (and track diversion blades used with Pre-Programmed™ models, if any) should be cleaned and lubricated periodically. We suggest once a year under normal circumstances. If used in an extremely dirty environment or used heavily, and, if panels become increasingly difficult to move, check to see if more frequent cleaning and lubrication will be necessary. We recommend a clear, odorless, lithium-based grease such as NGL1 - Grade 1.5 MOBILITH - SCH-PM.

The trolley bearings do not need to be cleaned or lubricated under normal circumstances. However, the guide rollers on the bottoms of the trolleys (and the diversion rollers on the tops and/or bottoms of the trolleys used with Pre-Programmed™ models), as shown in the images below, should be lubricated using WD-40 or similar to avoid squeaking or rough operation.

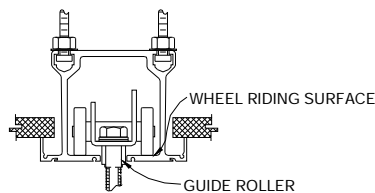

TYPE 7/8 TRACK

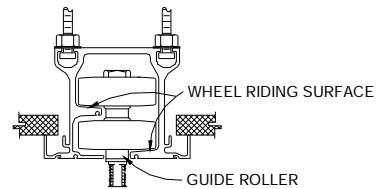

TYPE 9 TRACK WITH MULTI-DIRECTIONAL WHEELS

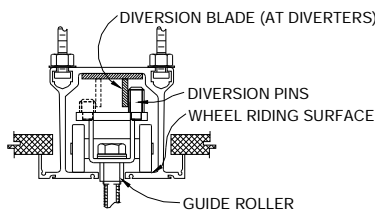

TYPE 7/8 TRACK WITH PRE-PROGRAMMED™ DIVERSION PINS

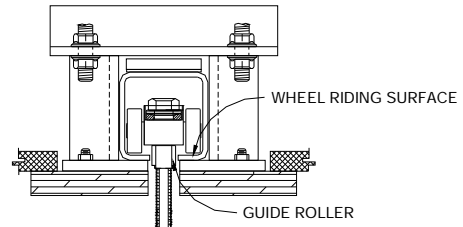

TYPE 5 TRACK

Maintaining Hinges

Panel, pass door and pocket door hinge pins, if any, should be checked and lubricated periodically using lithium-based grease, WD-40 or similar. Take care to protect panel faces during the lubrication process.

Maintaining Seals

The bronze-painted steel faces of the top and bottom operable seals, the flexible vinyl sweepseals on the bottoms of the pass doors and the vertical flexible vinyl seals on the panel edge astragals should be periodically cleaned by wiping them with a silicone impregnated cloth.

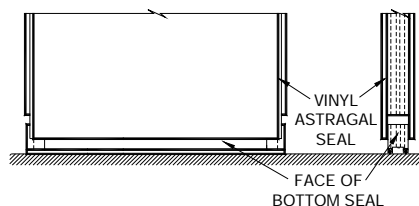

CLEANING THE SEALS

WORK SURFACES MAINTENANCE

Maintaining Markerboard Surfaces

For ANC operable walls fitted with dry erase markerboards, **use only dry erase markers**. Never use a permanent marker or it will cause permanent damage. The following care and maintenance information is quoted from the web site, www.cleanmyboard.com:

Care and Maintenance:

- For the initial cleaning, wipe your board with a clean cloth moistened by a liquid cleanser.
- Rinse with clear water. This step is simple but very important.
- Wipe dry with a clean cloth.
- If your board is used daily, the cleaning should be performed at least 2 to 3 times a week.

More thorough cleaning may be required if writing is left on the board for more than 2 days.

Removing Permanent Marker:

- Moisten a clean, dry cloth with isopropyl alcohol.
- Wipe the board in a circular motion to loosen marker residue.
- Rinse with clear water.
- Dry the board with a clean cloth.
- Repeat these steps as often as necessary to remove all residues.

Removing Crayon and Tape:

- Dampen a clean, dry cloth with water.
- Apply a small amount of non-abrasive cleanser, such as SoftScrub without bleach, onto the cloth. For best results, follow non-abrasive cleaner manufacturer's instructions found on the product label.
- Begin cleaning a small, manageable area using a back and forth horizontal motion. Use gentle pressure as if you were cleaning a window.
- Wipe off all residues with a dry cloth.
- Rinse well with clear water. Please note that the rinsing and drying steps are very important.
- Wipe dry with a clean cloth.
- Follow the same procedure for the remainder of the board.

Using Magnets

With the use of small magnets your markerboards and/or chalkboards become bulletin and display boards.

Maintaining Chalkboard Surfaces

For ANC operable walls fitted with chalkboards, we strongly recommend white chalk as opposed to yellow or other colored chalks. For special purposes, colored chalk can be used, but the added pigments in this chalk can make it more difficult to erase and are messier. A high grade chalk (95% chalk with 5% binder) will give better results than a 50% chalk content or chalks made of plaster or gypsum. Inferior chalk or low content chalk may permanently mark the chalkboard.

For optimal performance of your chalkboards, a simple "break-in" procedure is recommended. This improves the surface's write-ability and erase-ability. Just chalk all over the face of the chalk board using the flat side of a piece of chalk then erase. Now the chalkboard surface has been "broken-in."

Periodically cleaning the board with a clean cloth moistened with water, drying the board with another lint-free cloth, then "breaking-in" the board again with chalk will help keep your chalkboard clean and manageable through the years.

TWO YEAR LIMITED WARRANTY

Subject to the terms and conditions set forth below, ANC, Inc. warrants each new Moduflex[®] operable wall and accessory, each new PrimeSpacer[®] relocatable wall and accessory, and each new Scale/8[®], Scale/12[®], Sonicwal[®] and Fabricwal[®] folding partition and accessory to be free from defects in material and workmanship under normal use and service. ANC assumes no obligation to correct defects caused by improper installation or unreasonable use (including without limitation physical abuse or failure to provide reasonable and necessary maintenance). Panelfold's obligations under the warranty are limited to the repair or, at Panelfold's option, replacement, free of charge, of any defective part. This remedy is the purchaser's exclusive remedy for breach of warranty. Unless otherwise specifically agreed in writing by ANC, the duration of this warranty is two (2) years from the date of shipment from ANC. If the purchaser discovers within this period a defect in material or workmanship, it must promptly notify ANC in writing and must include a statement as to the nature of the as-erted defect. In no event shall such notification be received by ANC later than 25 months from the date of shipment from ANC may, at its option, require that the defective part be returned to the factory at the address set forth below, correctly packaged or crated for safe shipment, and with transportation charges prepaid by the party returning the product. No product covered by the warranty may be returned to the factory without prior written authorization from the factory. ANC accepts no responsibility or liability for products returned without such authorization. Requests for such authorization and authorized return shipments should be addressed to: ANC, Inc., 10700 N.W. 36th Avenue, Miami, Florida 33167, and must include the name and address of the party to whom the repaired part is to be returned.

DISCLAIMER OF WARRANTY

EXCEPT FOR THE EXPRESS WARRANTY PROVIDED HEREIN, ANC DISCLAIMS ALL OTHER WARRANTIES, EXPRESS OR IMPLIED, INCLUDING, BUT NOT LIMITED TO, THE IMPLIED WARRANTIES OF MERCHANTABILITY AND FITNESS FOR A PARTICULAR PURPOSE. ANC UNDERTAKES NO RESPONSIBILITY FOR THE QUALITY OF THE GOODS EXCEPT AS OTHERWISE PROVIDED IN THIS LIMITED WARRANTY. ANC ASSUMES NO RESPONSIBILITY THAT THE GOODS WILL BE FIT FOR ANY PARTICULAR PURPOSE FOR WHICH YOU MAY BE BUYING THESE GOODS, EXCEPT AS OTHERWISE PRO-VIDED IN THIS LIMITED WARRANTY.

LIMITATION OF LIABILITY

THE LIABILITY OF ANC, IF ANY, AND ANY PURCHASER'S SOLE AND EXCLUSIVE REMEDY FOR DAMAGES FOR ANY CLAIM OF ANY KIND WHATSOEVER, REGARDLESS OF THE LEGAL THEORY, SHALL NOT BE GREATER THAN THE ACTUAL PURCHASE PRICE PAID TO ANC FOR THE PRODUCT WITH RESPECT TO WHICH SUCH CLAIM IS MADE. IN NO EVENT SHALL ANC BE LIABLE FOR ANY SPECIAL, INDIRECT, INCIDENTAL, OR CONSEQUENTIAL DAMAGES OF ANY KIND INCLUDING, BUT NOT LIMITED TO, LOST PROFITS, BASED ON ANY LEGAL THEORY.

NO OTHER WARRANTY

NO PARTY OTHER THAN AN OFFICER OF ANC IS AUTHORIZED TO MAKE ANY ADDITIONAL OR OTHER WARRANTY ON BE-HALF OF ANC, INC. ON THESE PRODUCTS.